

CSCI 446: Artificial Intelligence

Constraint Satisfaction Problems



Instructor: Michele Van Dyne

Today

- Constraint Satisfaction Problems (CSPs)
- Using Search in CSPs
- Improving CSP Solutions
 - Backtracking
 - Filtering
 - Arc Consistency



What is Search For?

- Assumptions about the world: a single agent, deterministic actions, fully observed state, discrete state space
- Planning: sequences of actions
 - The path to the goal is the important thing
 - Paths have various costs, depths
 - Heuristics give problem-specific guidance
- Identification: assignments to variables
 - The goal itself is important, not the path
 - All paths at the same depth (for some formulations)
 - CSPs are specialized for identification problems

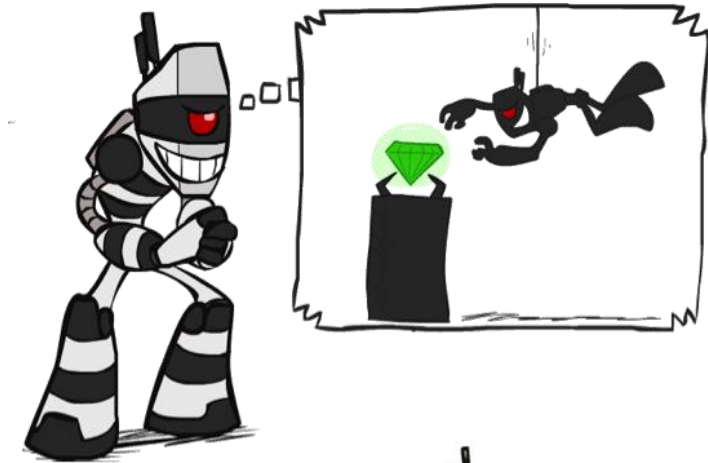

Constraint Satisfaction Problems

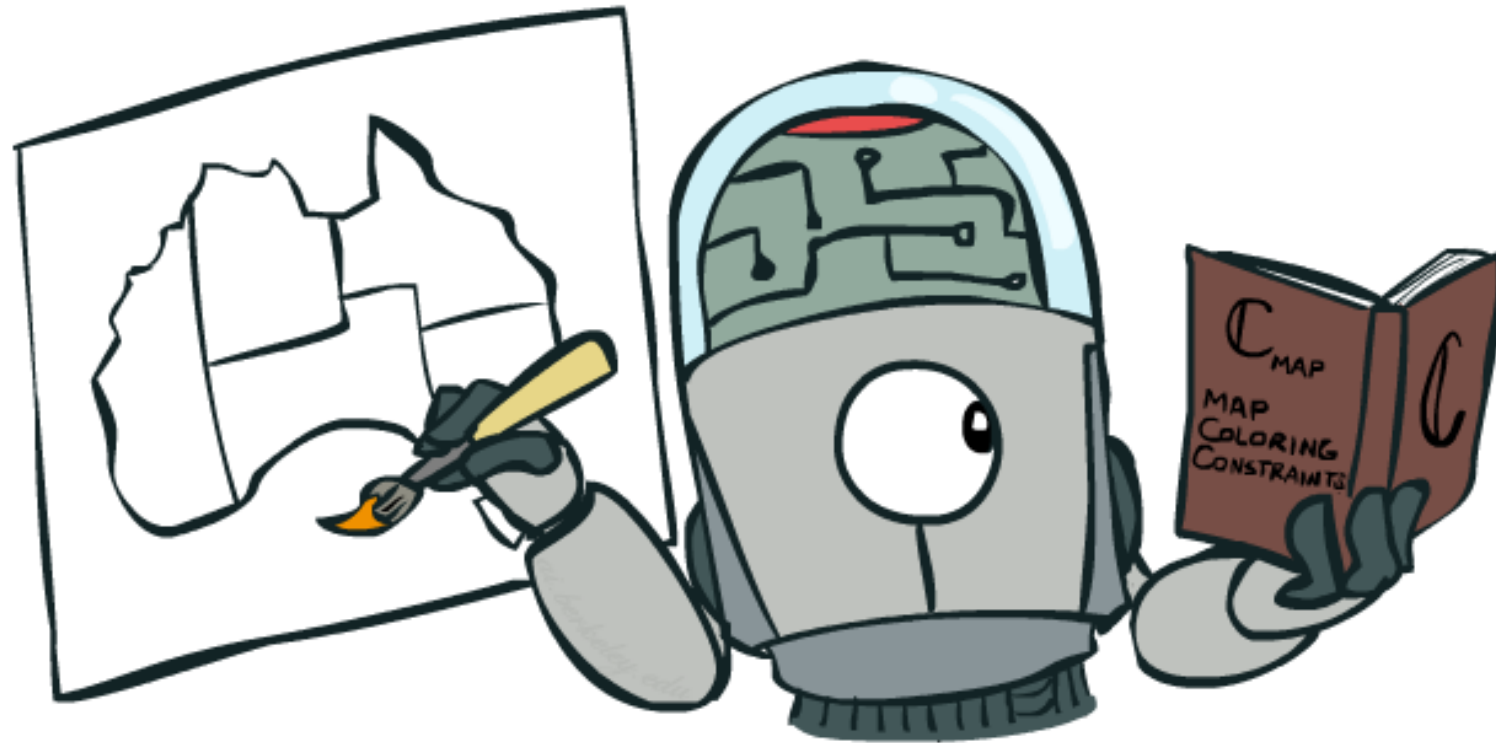

Constraint Satisfaction Problems

- Standard search problems:
 - State is a “black box”: arbitrary data structure
 - Goal test can be any function over states
 - Successor function can also be anything
- Constraint satisfaction problems (CSPs):
 - A special subset of search problems
 - State is defined by **variables X_i** with values from a **domain D** (sometimes D depends on i)
 - Goal test is a **set of constraints** specifying allowable combinations of values for subsets of variables
- Simple example of a *formal representation language*
- Allows useful general-purpose algorithms with more power than standard search algorithms

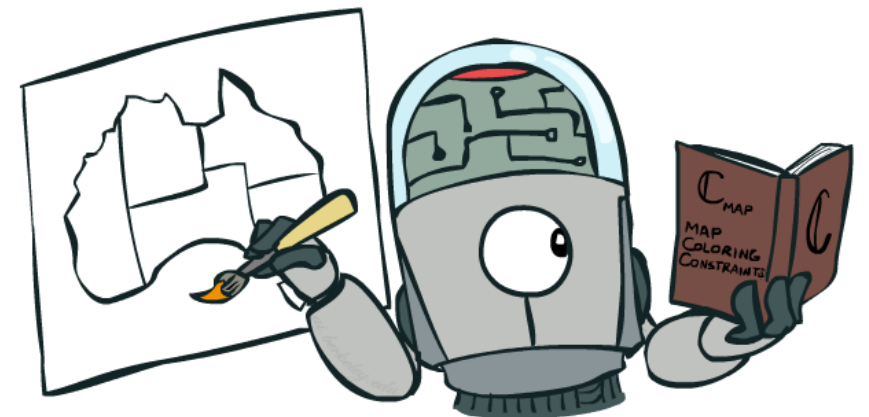
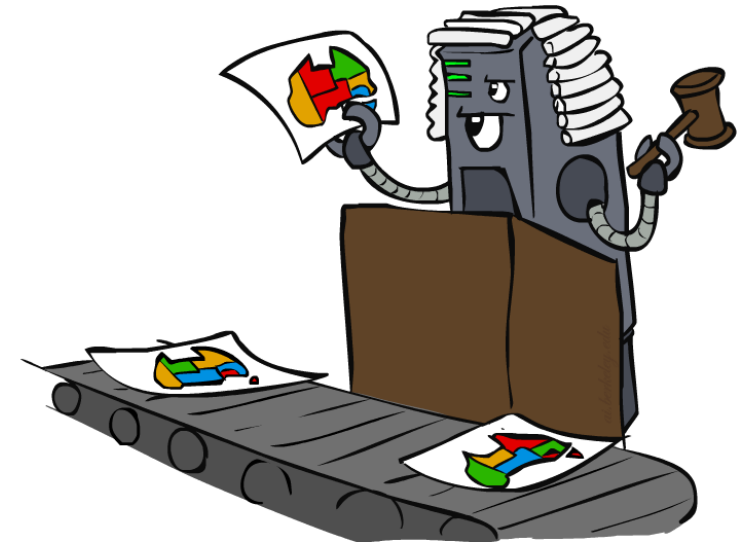

CSP Examples

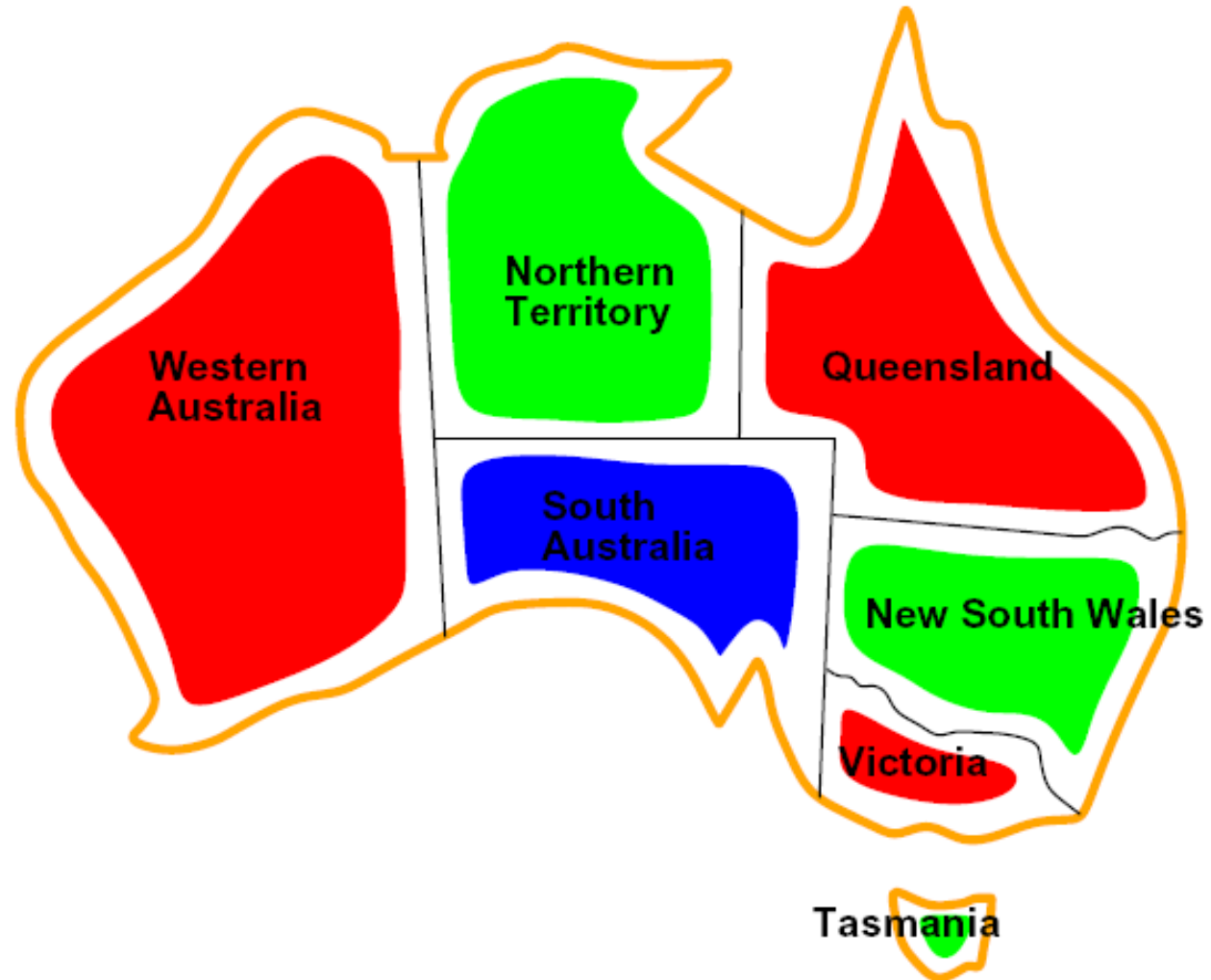

Example: Map Coloring

- Variables: WA, NT, Q, NSW, V, SA, T
- Domains: $D = \{\text{red, green, blue}\}$
- Constraints: adjacent regions must have different colors

Implicit: $WA \neq NT$

Explicit: $(WA, NT) \in \{(\text{red, green}), (\text{red, blue}), \dots\}$

- Solutions are assignments satisfying all constraints, e.g.:

$\{WA=\text{red}, NT=\text{green}, Q=\text{red}, NSW=\text{green}, V=\text{red}, SA=\text{blue}, T=\text{green}\}$

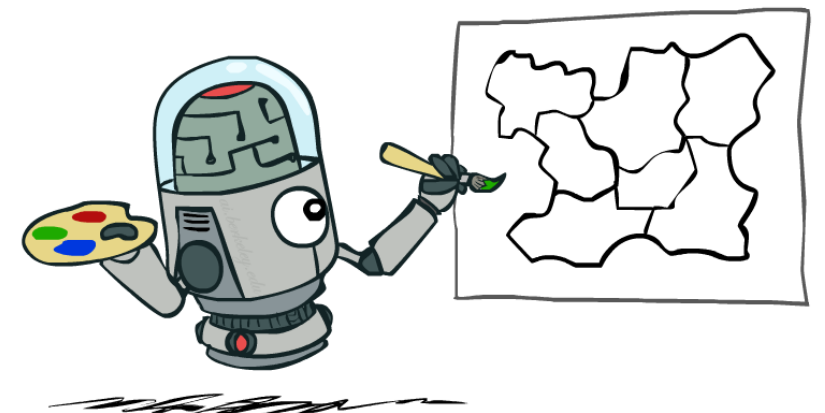
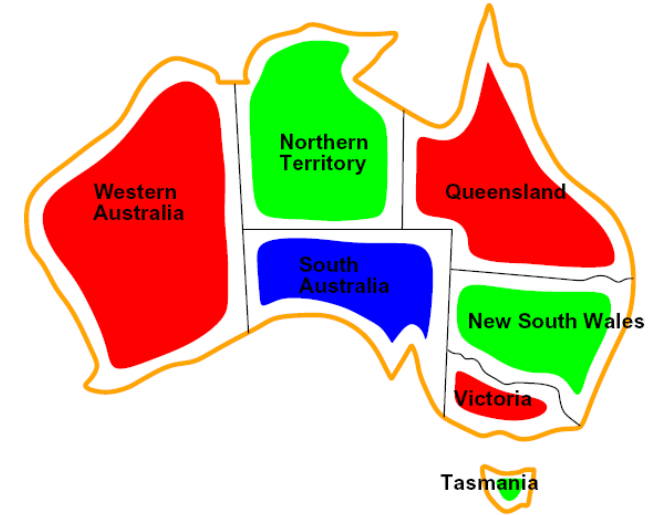

Example: N-Queens

- Formulation 1:

- Variables: X_{ij}
- Domains: $\{0, 1\}$
- Constraints

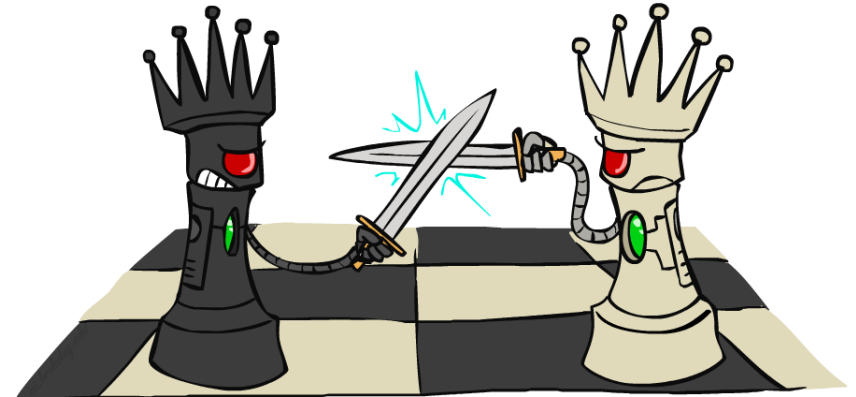
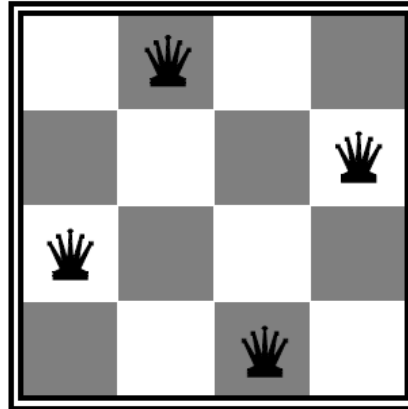

$$\forall i, j, k \quad (X_{ij}, X_{ik}) \in \{(0, 0), (0, 1), (1, 0)\}$$

$$\forall i, j, k \quad (X_{ij}, X_{kj}) \in \{(0, 0), (0, 1), (1, 0)\}$$

$$\forall i, j, k \quad (X_{ij}, X_{i+k, j+k}) \in \{(0, 0), (0, 1), (1, 0)\}$$

$$\forall i, j, k \quad (X_{ij}, X_{i+k, j-k}) \in \{(0, 0), (0, 1), (1, 0)\}$$

$$\sum_{i,j} X_{ij} = N$$

Example: N-Queens

- Formulation 2:

- Variables: Q_k

- Domains: $\{1, 2, 3, \dots, N\}$

- Constraints:

Implicit: $\forall i, j$ non-threatening(Q_i, Q_j)

Explicit: $(Q_1, Q_2) \in \{(1, 3), (1, 4), \dots\}$

...

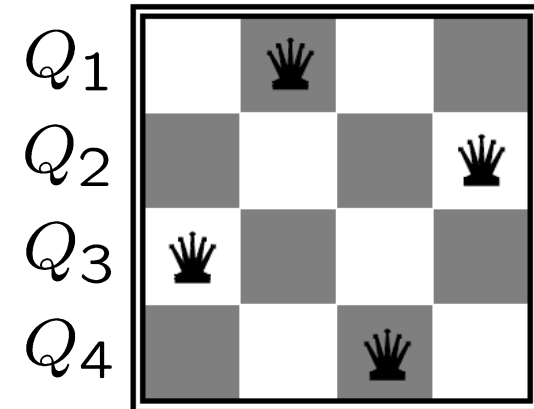

Constraint Graphs

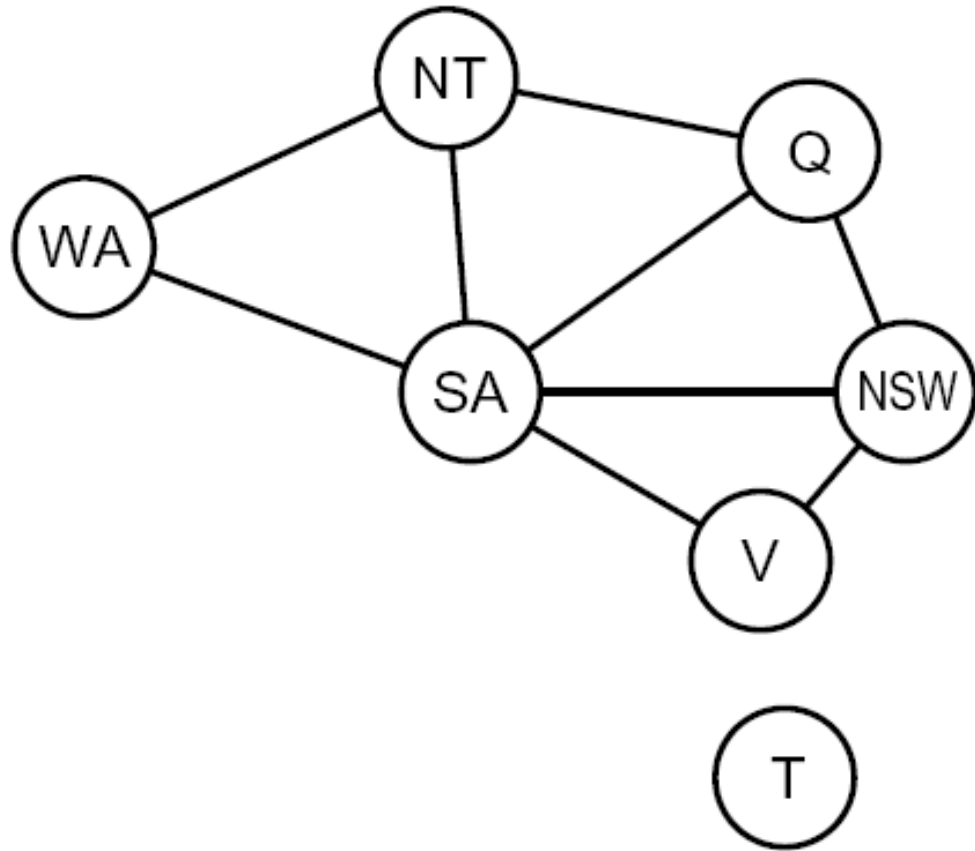

Constraint Graphs

- Binary CSP: each constraint relates (at most) two variables
- Binary constraint graph: nodes are variables, arcs show constraints
- General-purpose CSP algorithms use the graph structure to speed up search. E.g., Tasmania is an independent subproblem!

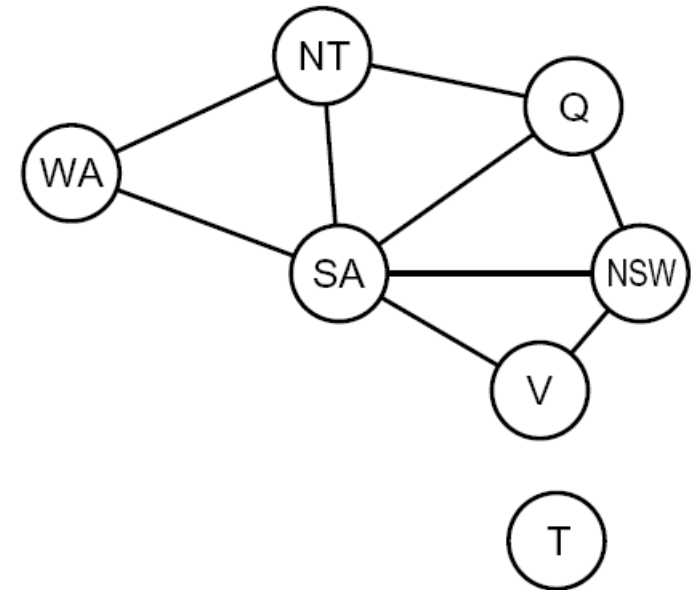

Screenshot of Demo N-Queens

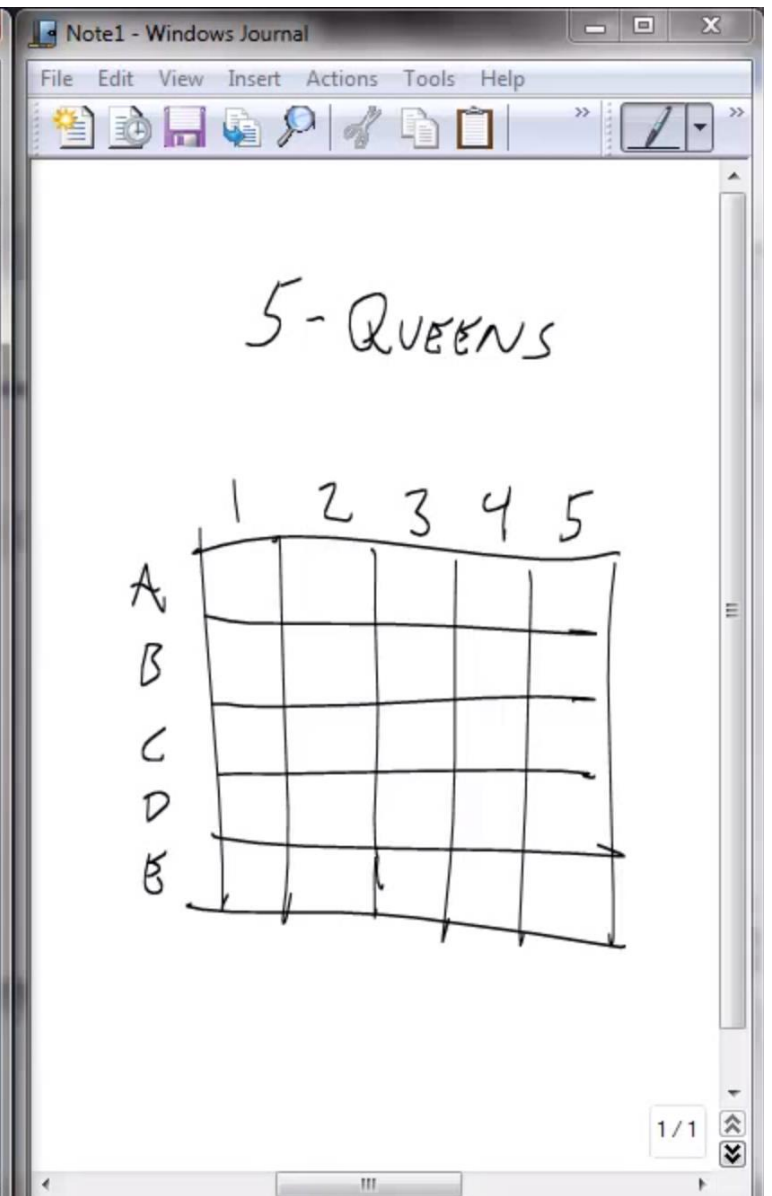
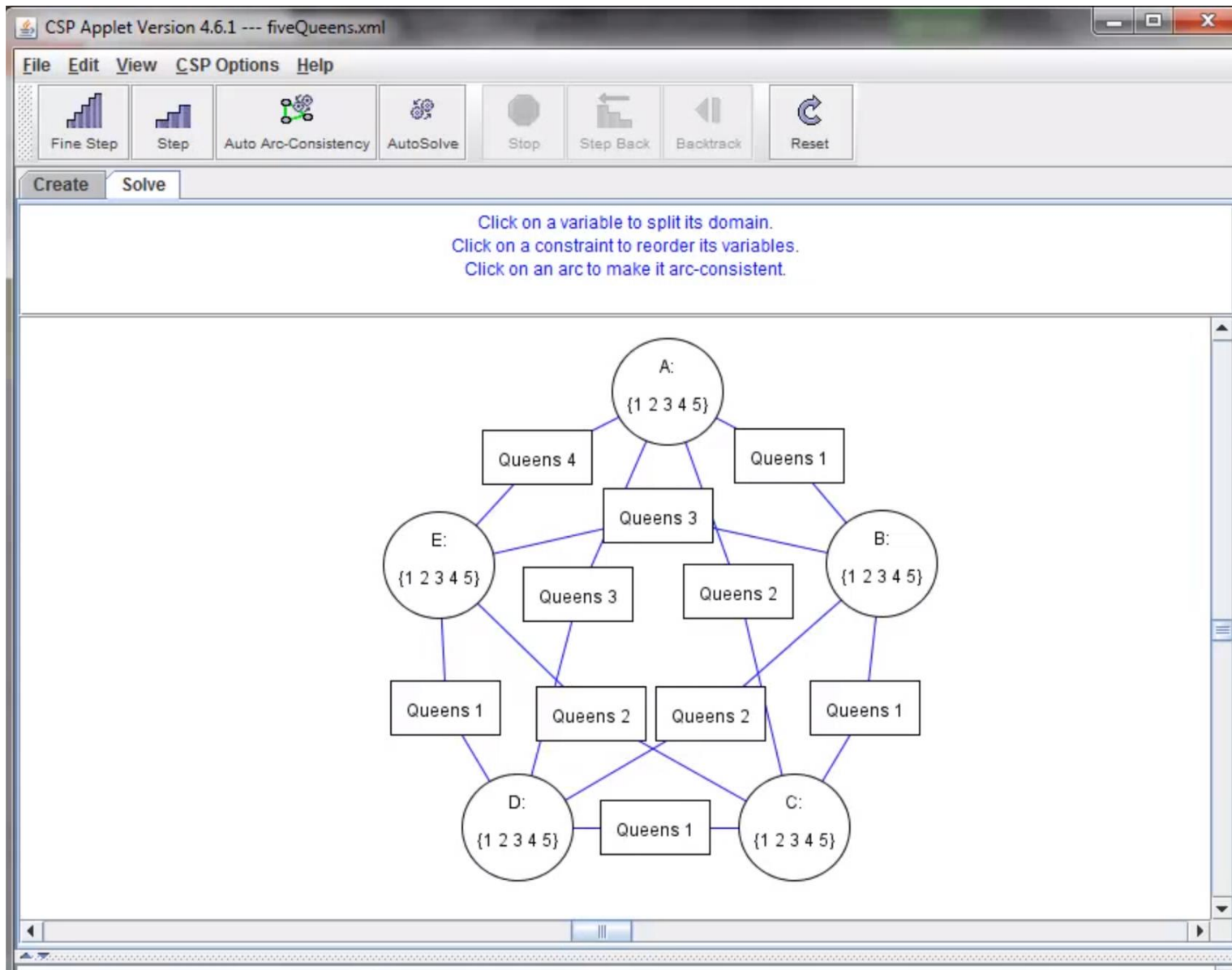

Example: Cryptarithmic

- Variables:

$F T U W R O X_1 X_2 X_3$

- Domains:

$\{0, 1, 2, 3, 4, 5, 6, 7, 8, 9\}$

- Constraints:

$\text{alldiff}(F, T, U, W, R, O)$

$O + O = R + 10 \cdot X_1$

...

$$\begin{array}{r} T W O \\ + T W O \\ \hline F O U R \end{array}$$

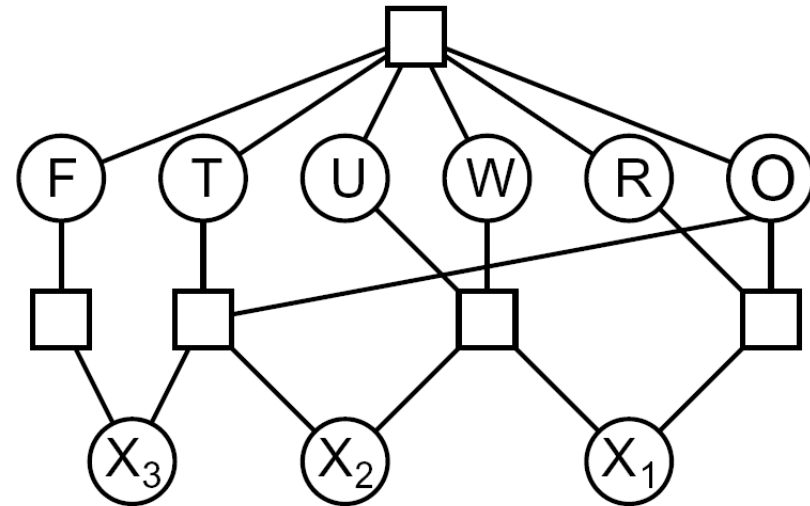

Example: Sudoku

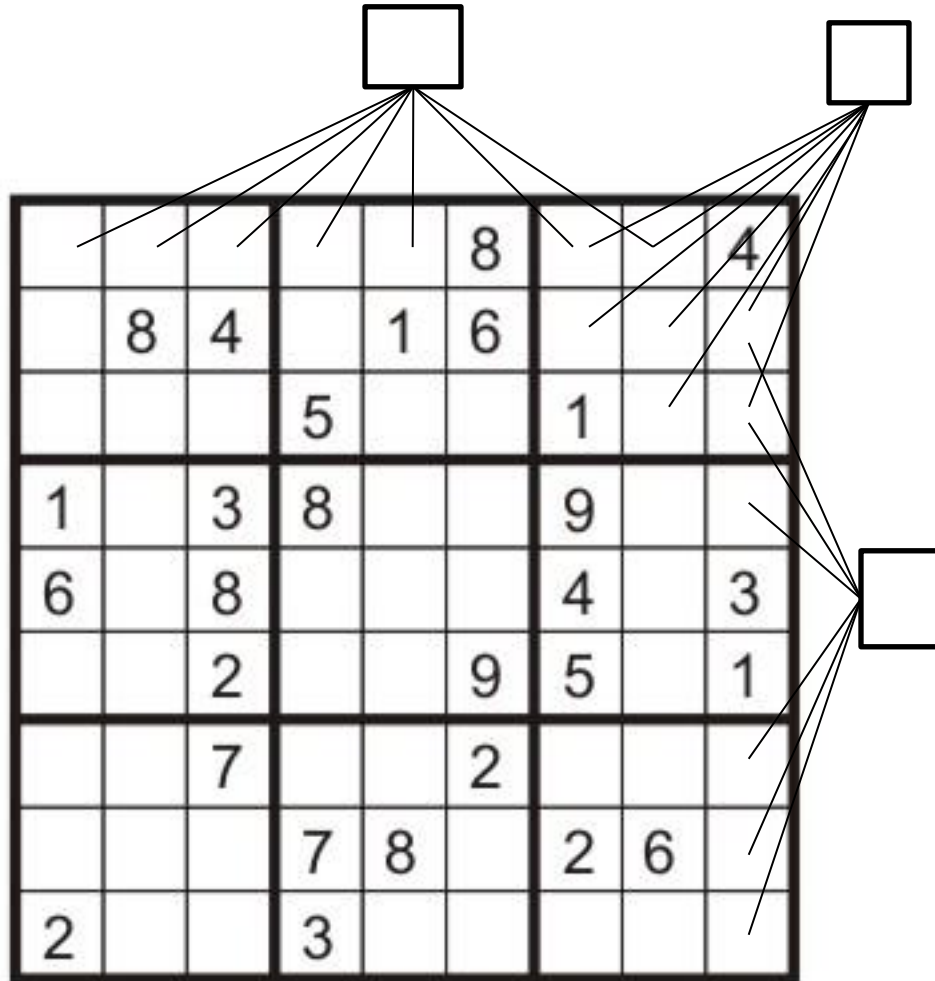

- Variables:
 - Each (open) square
- Domains:
 - {1,2,...,9}
- Constraints:

9-way alldiff for each column

9-way alldiff for each row

9-way alldiff for each region

(or can have a bunch of pairwise inequality constraints)

Example: The Waltz Algorithm

- The Waltz algorithm is for interpreting line drawings of solid polyhedra as 3D objects
- An early example of an AI computation posed as a CSP

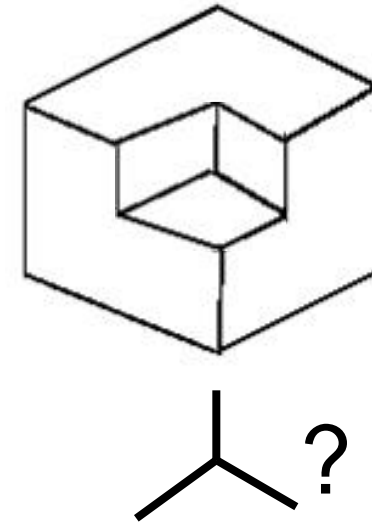
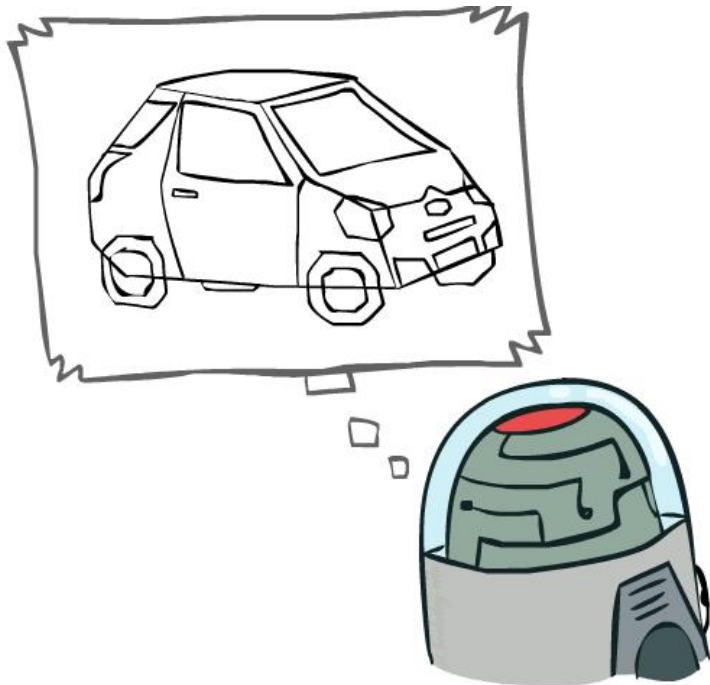

- Approach:
 - Each intersection is a variable
 - Adjacent intersections impose constraints on each other
 - Solutions are physically realizable 3D interpretations

Varieties of CSPs and Constraints

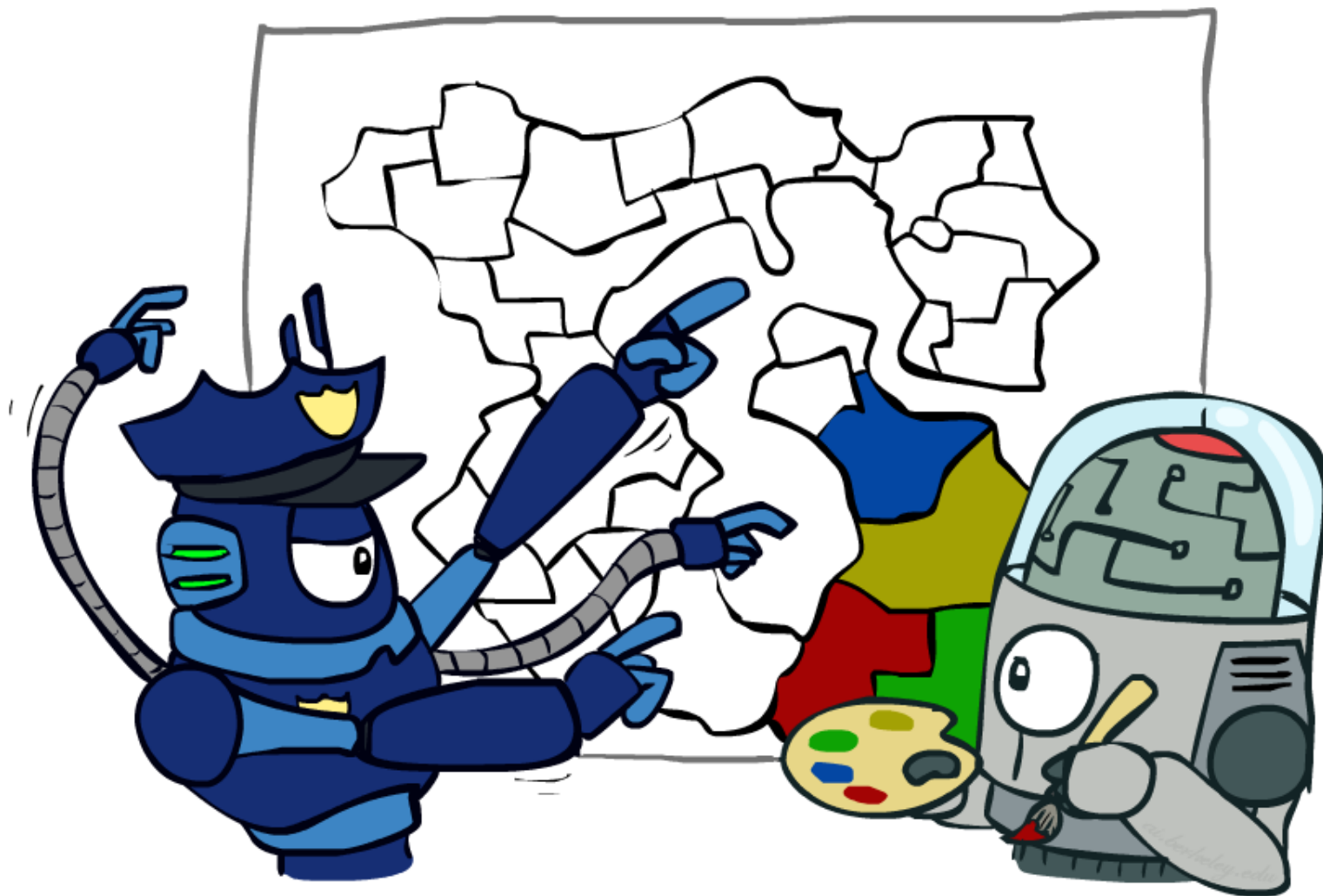

Varieties of CSPs

- Discrete Variables

- Finite domains
 - Size d means $O(d^n)$ complete assignments
 - E.g., Boolean CSPs, including Boolean satisfiability (NP-complete)
- Infinite domains (integers, strings, etc.)
 - E.g., job scheduling, variables are start/end times for each job
 - Linear constraints solvable, nonlinear undecidable

- Continuous variables

- E.g., start/end times for Hubble Telescope observations
- Linear constraints solvable in polynomial time by LP methods

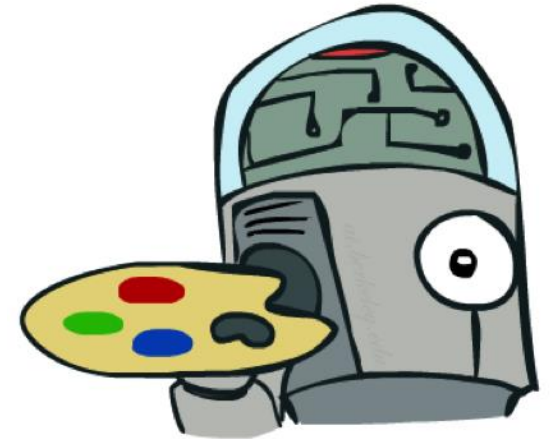

Varieties of Constraints

- Varieties of Constraints

- Unary constraints involve a single variable (equivalent to reducing domains), e.g.:

$$SA \neq \text{green}$$

- Binary constraints involve pairs of variables, e.g.:

$$SA \neq WA$$

- Higher-order constraints involve 3 or more variables:
e.g., cryptarithmic column constraints

- Preferences (soft constraints):

- E.g., red is better than green
- Often representable by a cost for each variable assignment
- Gives constrained optimization problems
- (We'll ignore these until we get to Bayes' nets)



Real-World CSPs

- Assignment problems: e.g., who teaches what class
- Timetabling problems: e.g., which class is offered when and where?
- Hardware configuration
- Transportation scheduling
- Factory scheduling
- Circuit layout
- Fault diagnosis
- ... lots more!

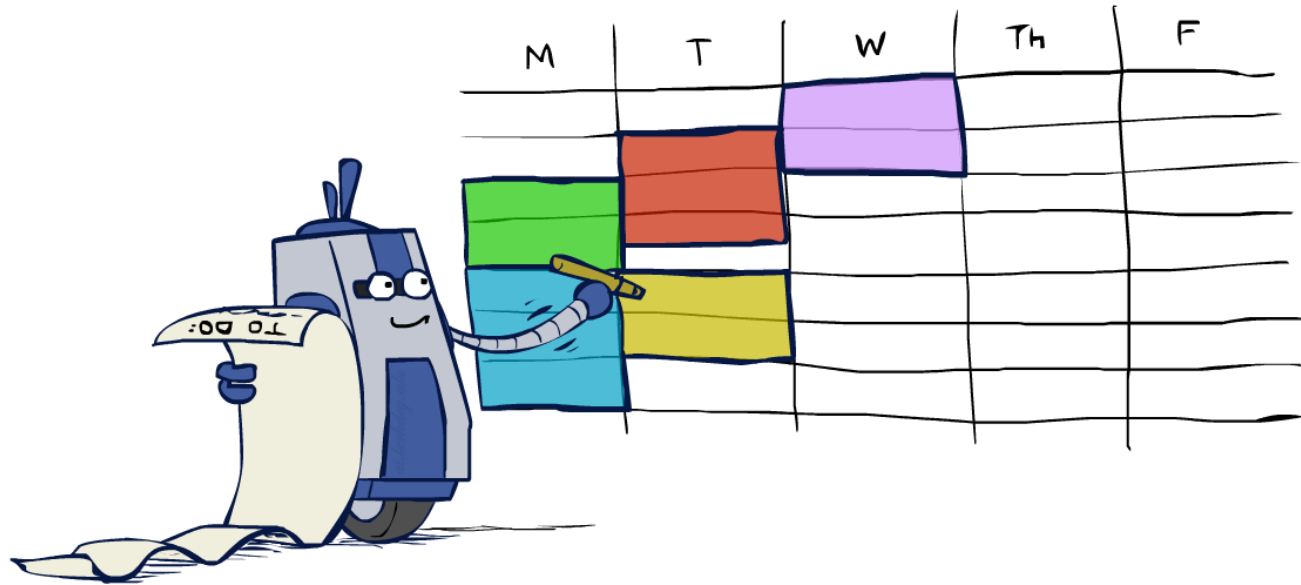

- Many real-world problems involve real-valued variables...

Solving CSPs



Standard Search Formulation

- Standard search formulation of CSPs
- States defined by the values assigned so far (partial assignments)
 - Initial state: the empty assignment, $\{\}$
 - Successor function: assign a value to an unassigned variable
 - Goal test: the current assignment is complete and satisfies all constraints
- We'll start with the straightforward, naïve approach, then improve it

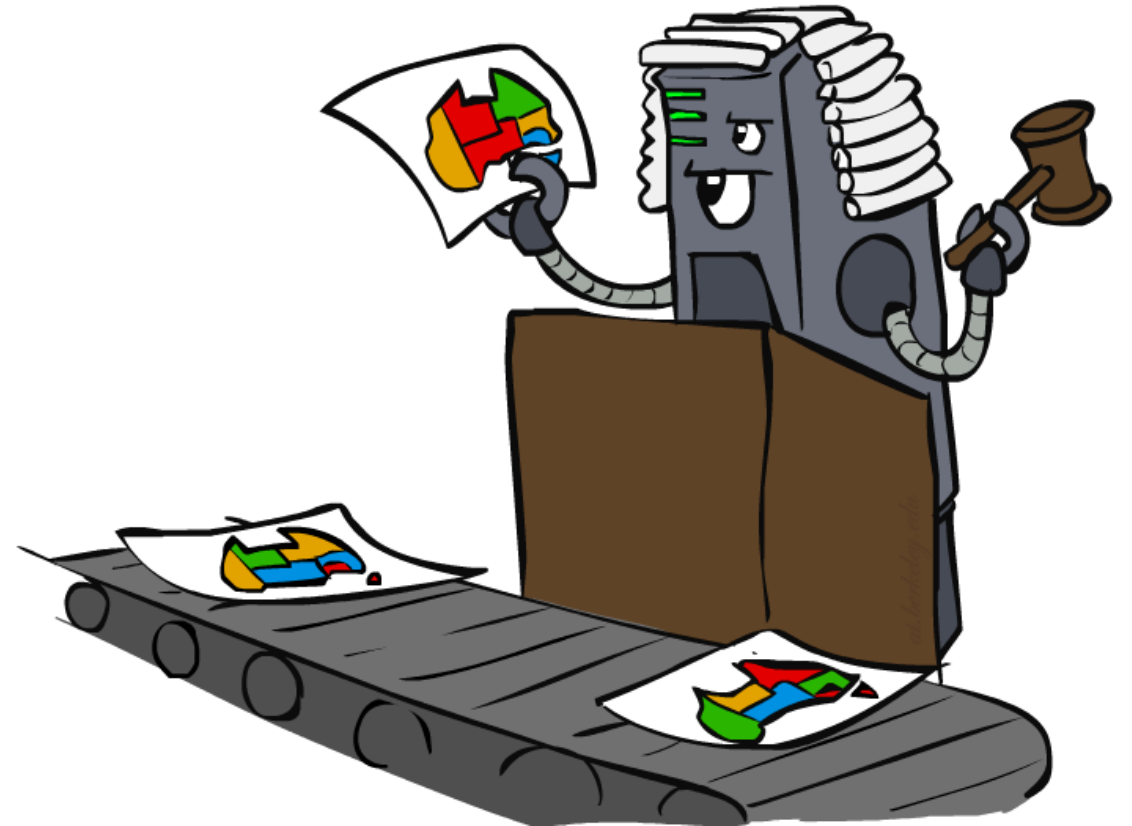

Search Methods

- What would BFS do?
- What would DFS do?
- What problems does naïve search have?

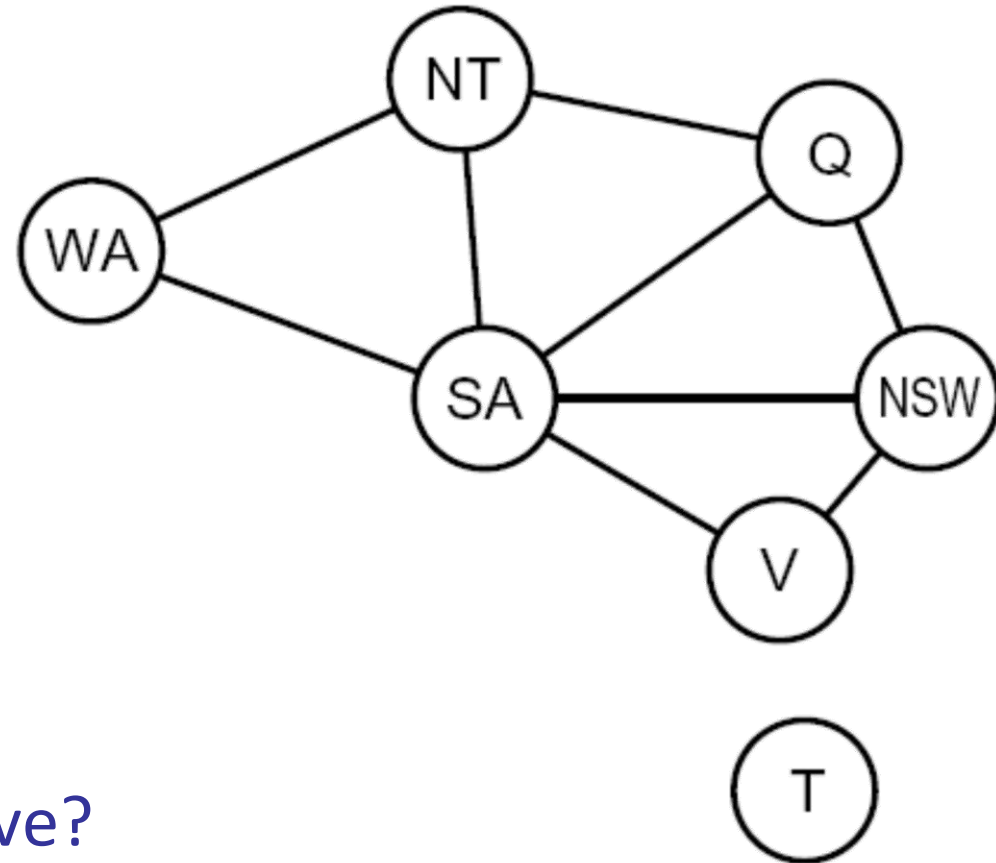

Backtracking Search

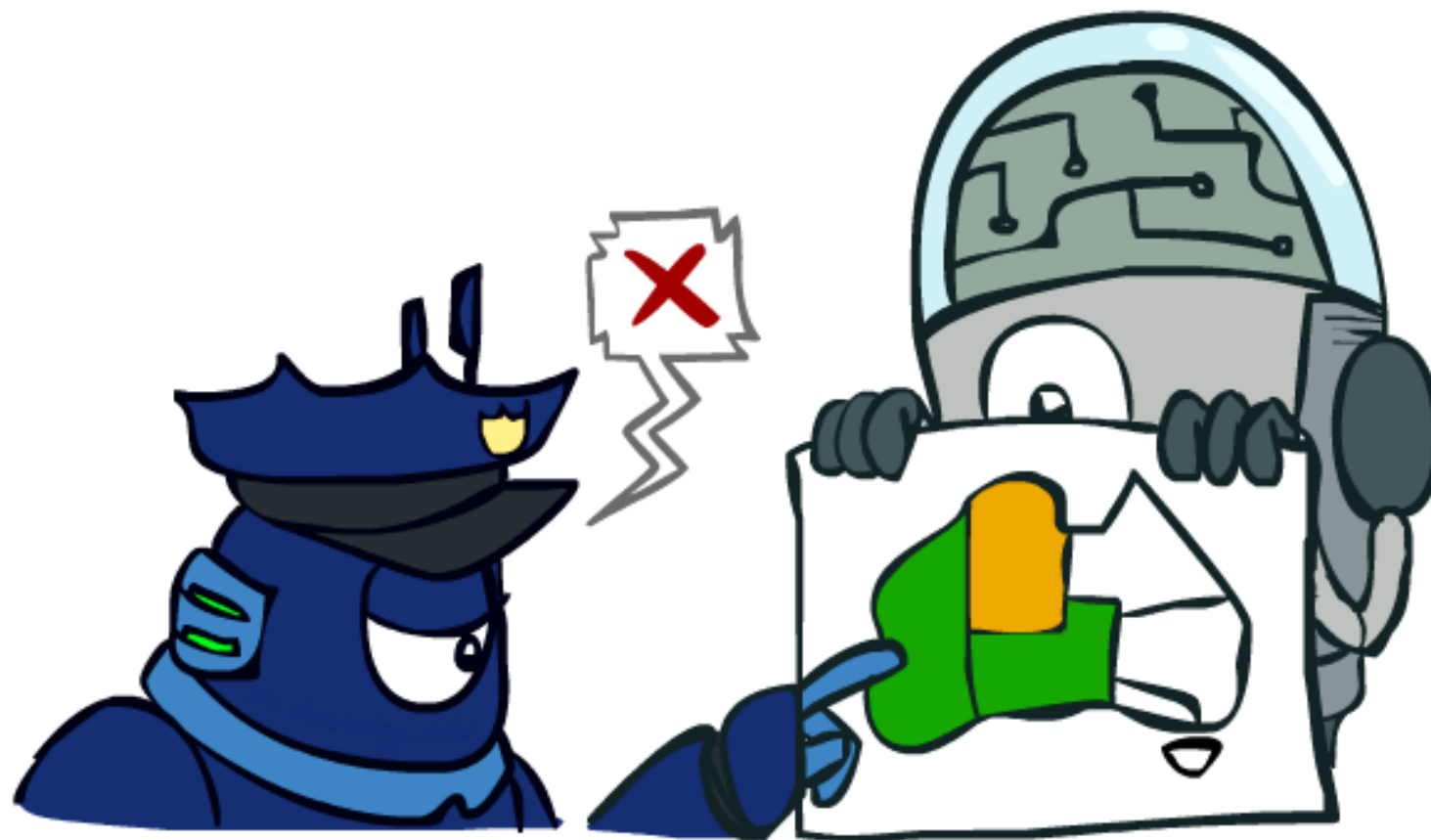

Backtracking Search

- Backtracking search is the basic uninformed algorithm for solving CSPs
- Idea 1: One variable at a time
 - Variable assignments are commutative, so fix ordering
 - I.e., [WA = red then NT = green] same as [NT = green then WA = red]
 - Only need to consider assignments to a single variable at each step
- Idea 2: Check constraints as you go
 - I.e. consider only values which do not conflict previous assignments
 - Might have to do some computation to check the constraint
 - “Incremental goal test”
- Depth-first search with these two improvements is called *backtracking search* (not the best name)
- Can solve n-queens for $n \approx 25$

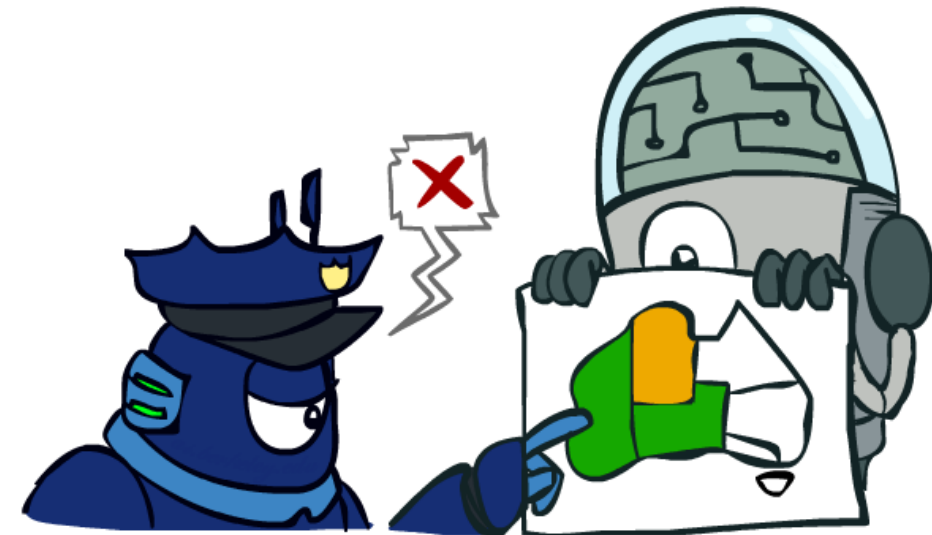

Backtracking Example

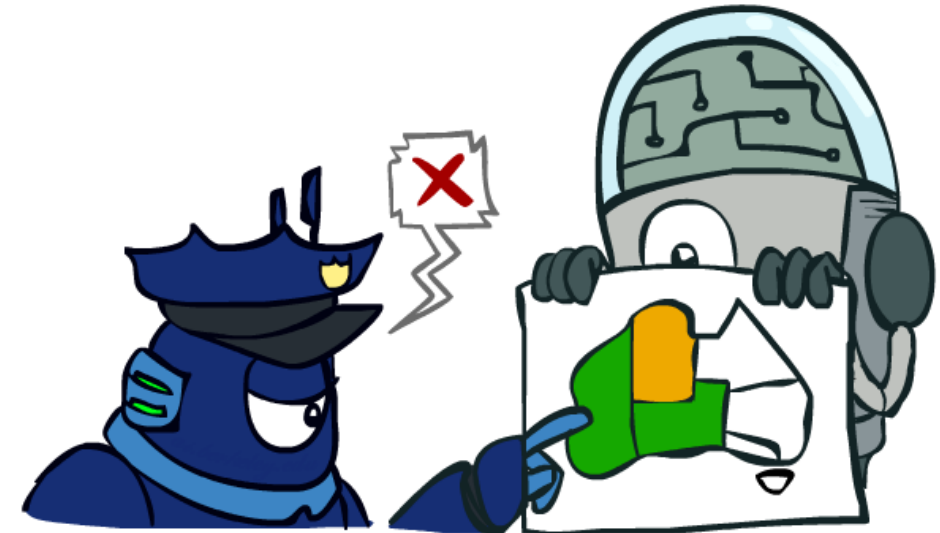
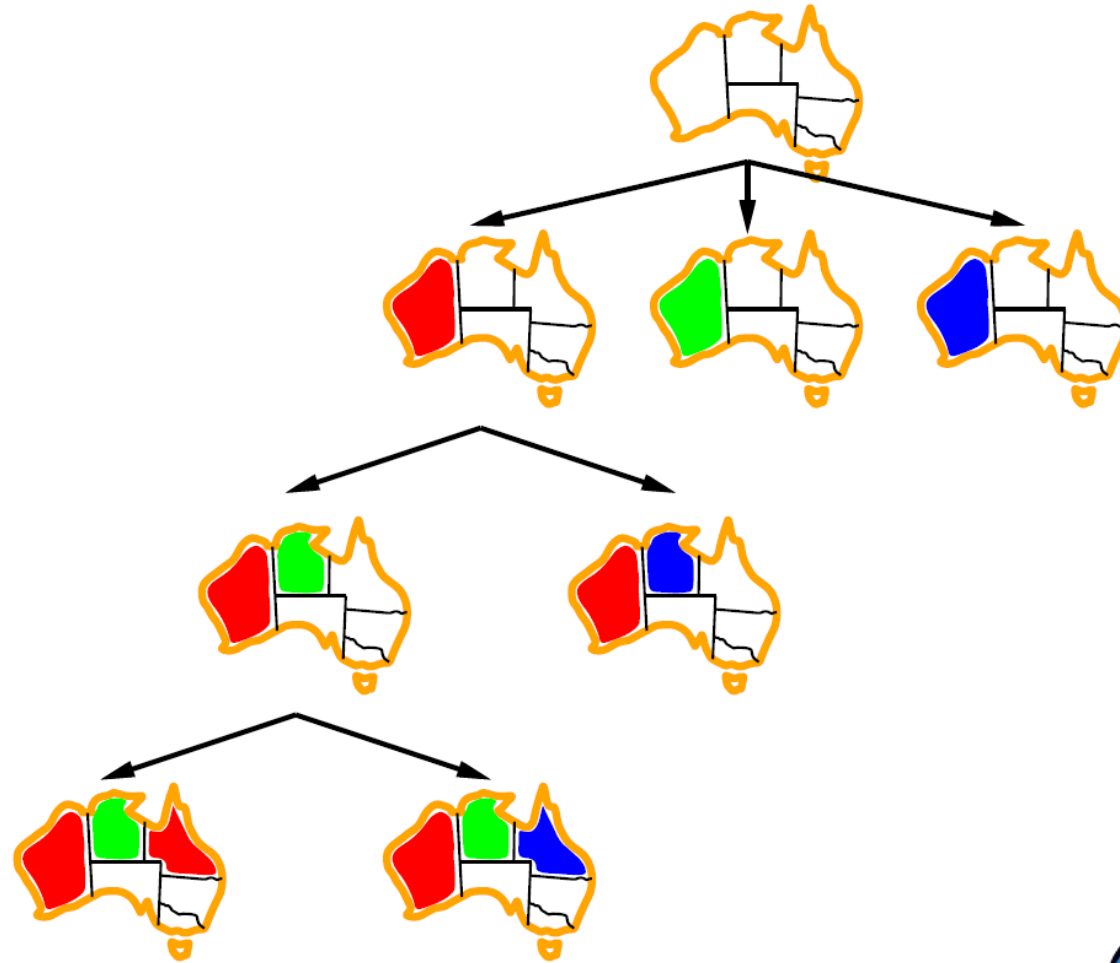

Backtracking Search

```
function BACKTRACKING-SEARCH(csp) returns solution/failure
  return RECURSIVE-BACKTRACKING({ }, csp)

function RECURSIVE-BACKTRACKING(assignment, csp) returns soln/failure
  if assignment is complete then return assignment
  var ← SELECT-UNASSIGNED-VARIABLE(VARIABLES[csp], assignment, csp)
  for each value in ORDER-DOMAIN-VALUES(var, assignment, csp) do
    if value is consistent with assignment given CONSTRAINTS[csp] then
      add {var = value} to assignment
      result ← RECURSIVE-BACKTRACKING(assignment, csp)
      if result ≠ failure then return result
      remove {var = value} from assignment
  return failure
```

- Backtracking = DFS + variable-ordering + fail-on-violation
- What are the choice points?

Improving Backtracking

- General-purpose ideas give huge gains in speed
- Ordering:
 - Which variable should be assigned next?
 - In what order should its values be tried?
- Filtering: Can we detect inevitable failure early?
- Structure: Can we exploit the problem structure?

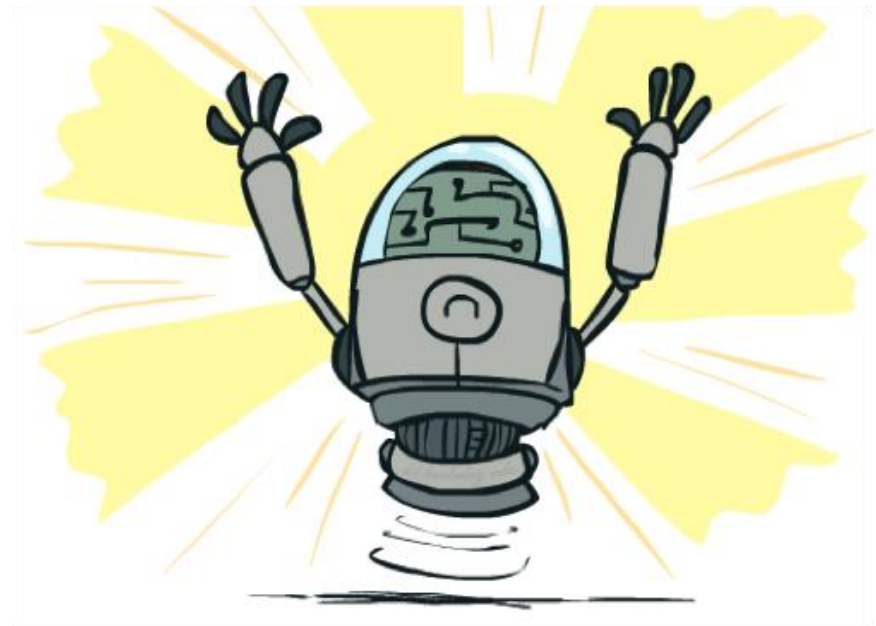

Filtering



Filtering: Forward Checking

- Filtering: Keep track of domains for unassigned variables and cross off bad options
- Forward checking: Cross off values that violate a constraint when added to the existing assignment



Filtering: Constraint Propagation

- Forward checking propagates information from assigned to unassigned variables, but doesn't provide early detection for all failures:

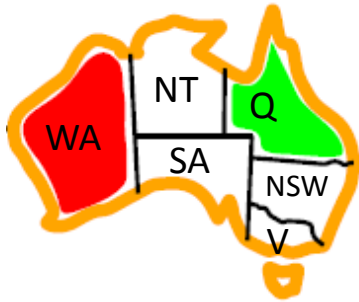

- NT and SA cannot both be blue!
- Why didn't we detect this yet?
- Constraint propagation*: reason from constraint to constraint

Consistency of A Single Arc

- An arc $X \rightarrow Y$ is **consistent** iff for *every* x in the tail there is *some* y in the head which could be assigned without violating a constraint

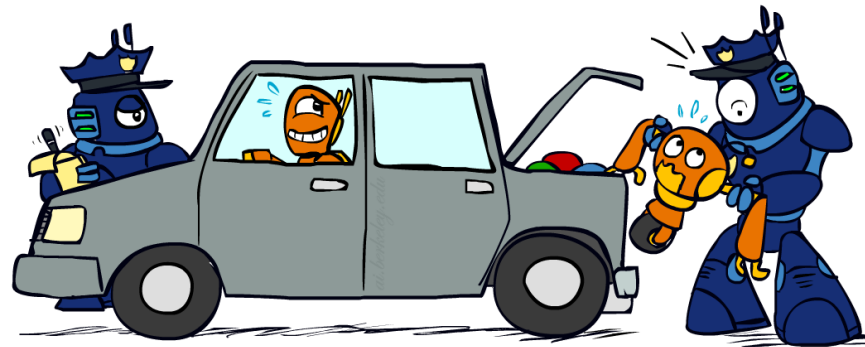
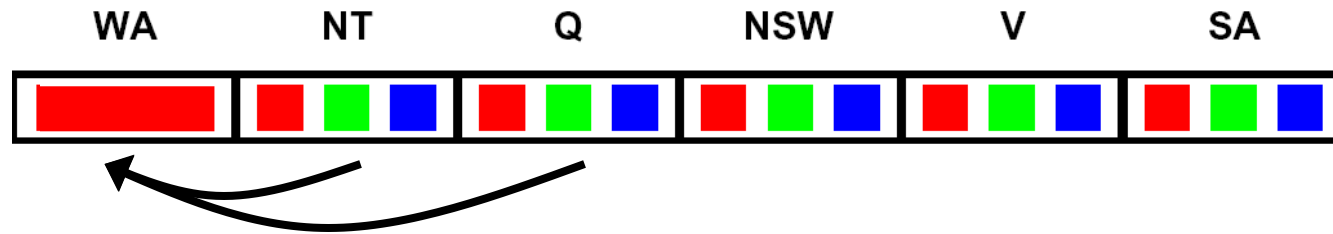
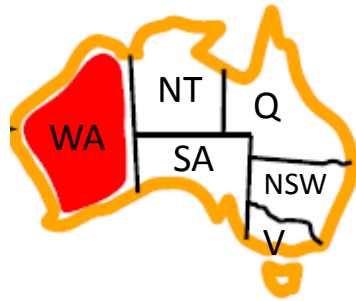

Delete from the tail!

- Forward checking: Enforcing consistency of arcs pointing to each new assignment

Arc Consistency of an Entire CSP

- A simple form of propagation makes sure **all** arcs are consistent:

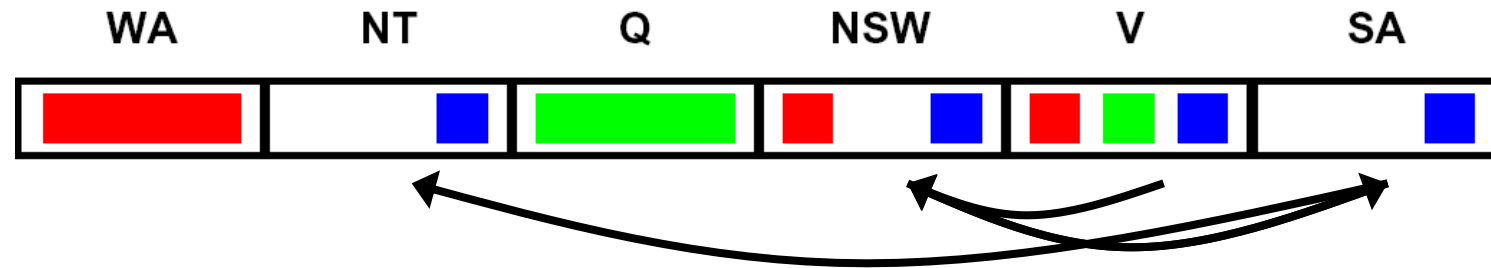
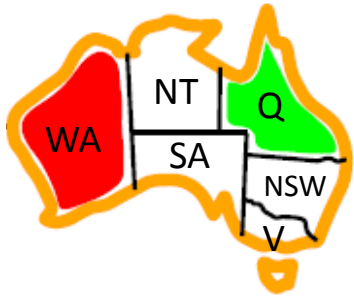

- Important: If X loses a value, neighbors of X need to be rechecked!
- Arc consistency detects failure earlier than forward checking
- Can be run as a preprocessor or after each assignment
- What's the downside of enforcing arc consistency?

Remember: Delete from the tail!

Enforcing Arc Consistency in a CSP

```
function AC-3(csp) returns the CSP, possibly with reduced domains
inputs: csp, a binary CSP with variables  $\{X_1, X_2, \dots, X_n\}$ 
local variables: queue, a queue of arcs, initially all the arcs in csp

while queue is not empty do
     $(X_i, X_j) \leftarrow \text{REMOVE-FIRST}(\textit{queue})$ 
    if REMOVE-INCONSISTENT-VALUES( $X_i, X_j$ ) then
        for each  $X_k$  in NEIGHBORS[ $X_i$ ] do
            add  $(X_k, X_i)$  to queue

```

```
function REMOVE-INCONSISTENT-VALUES( $X_i, X_j$ ) returns true iff succeeds
    removed  $\leftarrow$  false
    for each  $x$  in DOMAIN[ $X_i$ ] do
        if no value  $y$  in DOMAIN[ $X_j$ ] allows  $(x, y)$  to satisfy the constraint  $X_i \leftrightarrow X_j$ 
            then delete  $x$  from DOMAIN[ $X_i$ ]; removed  $\leftarrow$  true
    return removed

```

- Runtime: $O(n^2d^3)$, can be reduced to $O(n^2d^2)$
- ... but detecting all possible future problems is NP-hard – why?

Limitations of Arc Consistency

- After enforcing arc consistency:
 - Can have one solution left
 - Can have multiple solutions left
 - Can have no solutions left (and not know it)
- Arc consistency still runs inside a backtracking search!

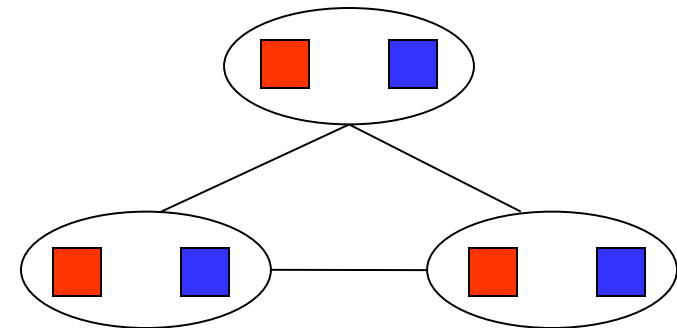
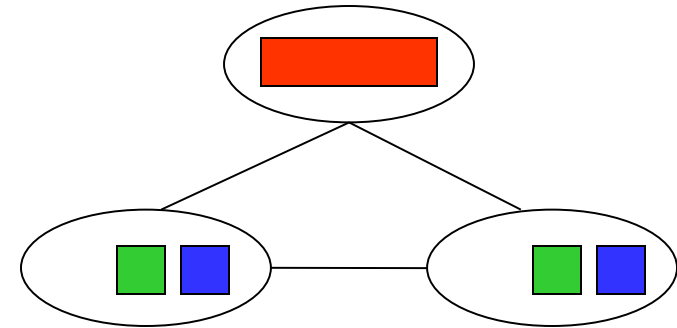

What went wrong here?

[Demo: coloring -- forward checking]

[Demo: coloring -- arc consistency]

Ordering



Ordering: Minimum Remaining Values

- Variable Ordering: Minimum remaining values (MRV):
 - Choose the variable with the fewest legal left values in its domain



- Why min rather than max?
- Also called “most constrained variable”
- “Fail-fast” ordering

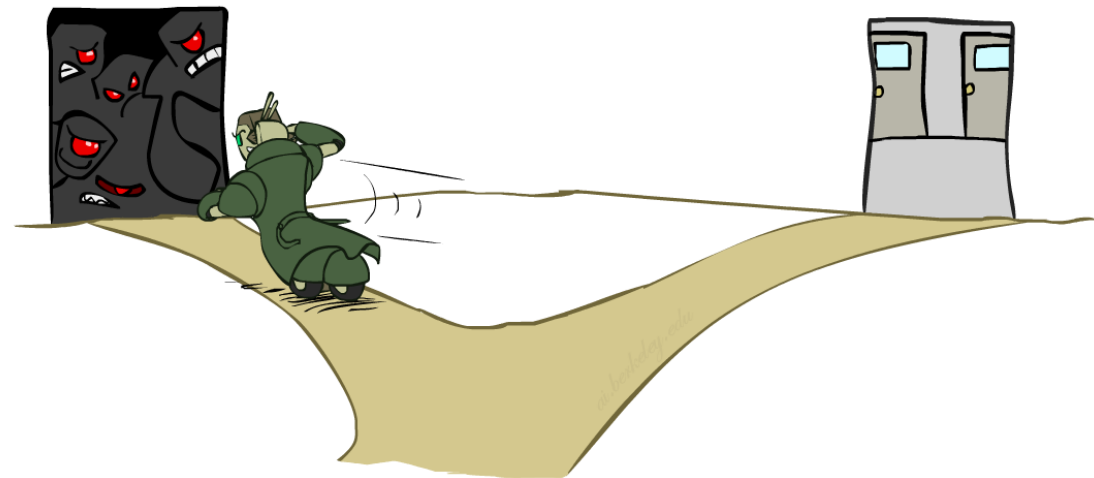

Ordering: Least Constraining Value

- Value Ordering: Least Constraining Value
 - Given a choice of variable, choose the *least constraining value*
 - I.e., the one that rules out the fewest values in the remaining variables
 - Note that it may take some computation to determine this! (E.g., rerunning filtering)
- Why least rather than most?
- Combining these ordering ideas makes 1000 queens feasible

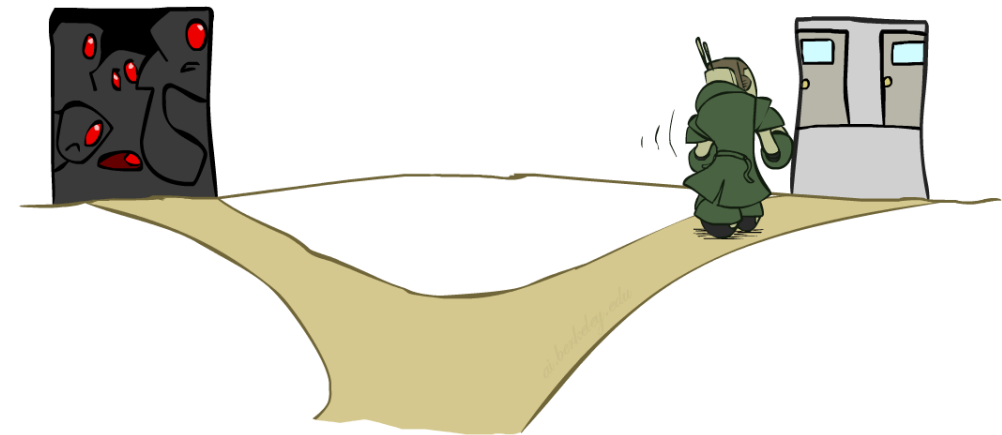
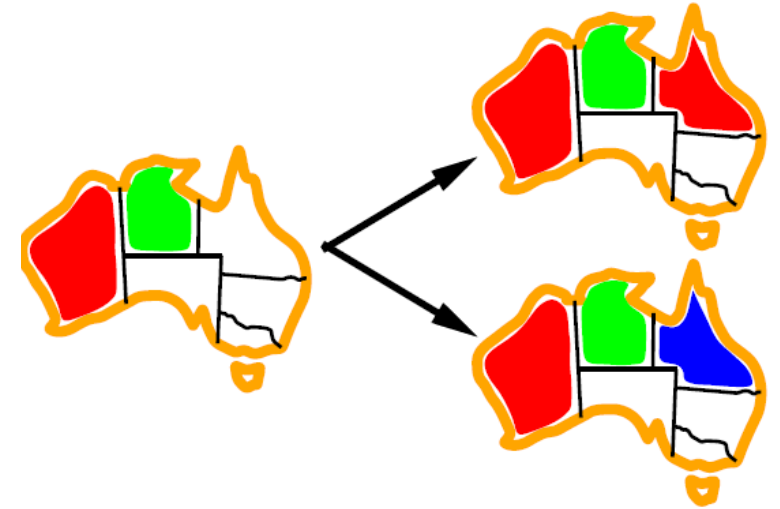

Today

- Constraint Satisfaction Problems (CSPs)
- Using Search in CSPs
- Improving CSP Solutions
 - Backtracking
 - Filtering
 - Arc Consistency

